



Worldwide Leaders
in **Static Control**

INDUSTRIAL PRODUCT CATALOG



STATIC NEUTRALIZING • STATIC CHARGING • WEB & SHEET CLEANING

Table of Contents

Static Basics2

Electrostatic Fieldmeter & TensION3

Static Neutralization Systems4

IQ Power.....4

IQ Easy6

MEB.....7

Ionizing Nozzles.....8

HS Nozzle.....8

IQ Power Nozzle.....8

HE Nozzle.....9

Ioncell9

Ionizing Air Guns10

Top Gun.....10

Cobra.....10

Ionizing Air Knives11

Curtain Transvector.....11

Magnum Force Air Knife System.....12

Ionizing Air Blowers.....13

Phoenix13

Aerostat PC13

Sentry.....14

Aerostat XP-20F.....14

In-Line Ionizers.....15

Conveyostat.....15

Electrostatic Charging16

Chargemaster VCM.....16

Chargemaster CM20.....16

Pinner & Pinner T17

Pinner LP.....17

Charging Applicators17

Pinner Superbar18

Pinner Easy.....18

MCM 30.....18

Web and Sheet Cleaning Systems19

Teknek Contact Cleaners.....19

Narrow Web Vacuum System.....20

Neutro-Vac Web/Sheet Cleaner21

About Simco-Ion

Simco-Ion is the unsurpassed leader in solving static control problems in a wide range of industries. Since 1936, Simco-Ion has distinguished itself by manufacturing innovative, high quality static control products and providing outstanding customer service and application expertise.

Simco-Ion Manufacturing Locations

(contact information on back cover)



United States



Holland



Japan



China



Why Is Static Control Important?

Managing static electricity is important for several reasons. The most notable being contamination control, operator safety, and minimizing process equipment issues that can occur due to high static charges. Contamination control is a significant issue in many manufacturing environments, especially in critical applications such as food, medical or pharmaceutical packaging.

Operator safety is also a critical concern because high static charges can cause significant electrostatic shocks to unsuspecting personnel, or worse, an electrostatic discharge in a solvent coating application could cause a fire hazard. The biggest issue for most manufacturers is that all of these problems resulting from static electricity impact their bottom-line.

Static electricity is best controlled by using an air ionization device to neutralize the charges. Active electrical ionizers are the most effective devices for eliminating static, which are strategically located in the process to manage the problems identified above.

The equipment available ranges from basic static control to fully integrated systems that monitor the performance of the ionizer, providing alarm signals to the PLC for critical process control, or data logging capabilities for high-end customer requirements.

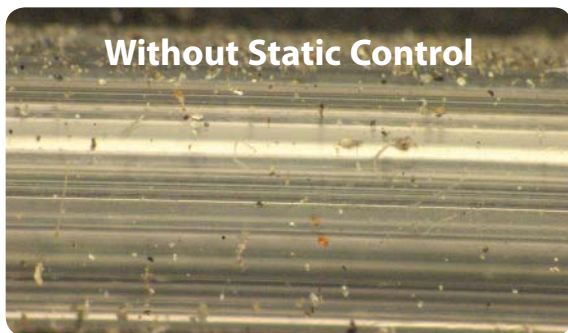
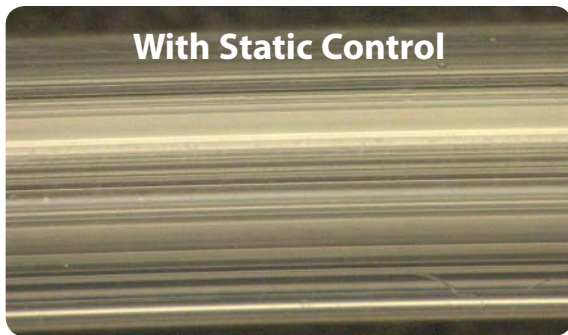

Catheter manufacturing after thirty (30) minutes of exposure.

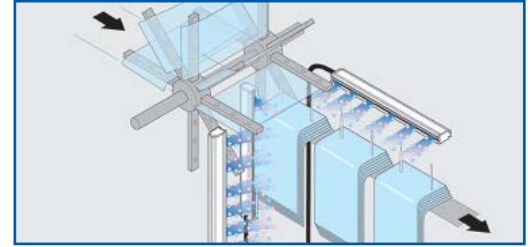

Converting

Simco-Ion's products provide solutions in critical converting processes that can be affected by static including bag-making, sheeting and slitting, laminating and coating, gravure printing, rewinding, trim collection, web cleaning and roll-to-roll changeover.

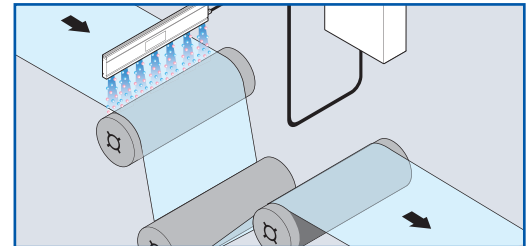

Plastic

Simco-Ion solves problems for a variety of plastics applications including film extrusion, injection molding, thermoforming, trim collection coating, laminating, chill roller pinning, blow molding and in-mold labeling.

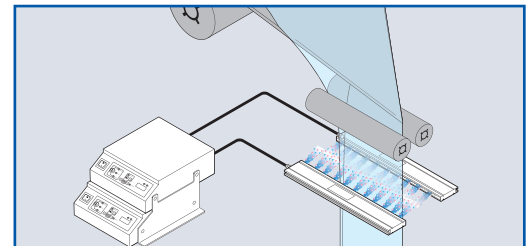

Printing

Today's print customers demand high quality printed material at competitive prices. Simco-Ion's static control products, cleaning systems and static bonding equipment guarantees that your customers will get higher quality printed materials. At the same time your production cost are lowered and throughput increased.

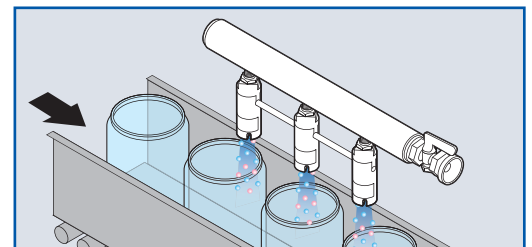

Packaging

Static charges can cause problems in many areas of packaging processes. Simco-Ion's products can eliminate these problems in a variety of applications including package printing, bottling, labeling, thermoforming, overwrapping, trim collection, and form, fill and seal operations.

How is Static Generated?

Static electricity is a surface phenomenon and results when two or more surfaces are in intimate contact with each other and then are separated. During contact, surface electrons, which are negative, migrate from one surface to the adjacent surface. When the surfaces separate, the surface that gains the electrons becomes negatively charged, the surface giving them up becomes positively charged.

Many industrial materials are insulators, such as rubber, glass and plastics. Their desirable qualities make them essential to use, however, they are likely to become electrostatically charged during processing.

These processes include:

- Peeling laminate
- Unwinding a roll
- Separating surfaces
- Wind-up operations
- Collecting products in bins

Production jams, quality problems, dirt attraction and rejects are all consequences of uncontrolled static.

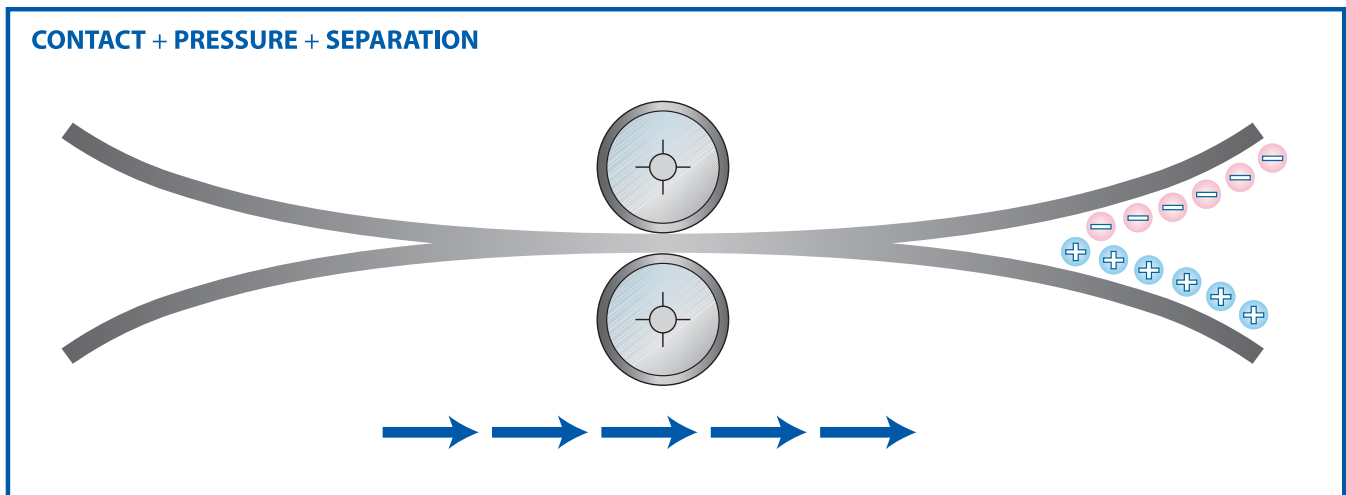

Friction, pressure and separation are the major causes of static electricity.

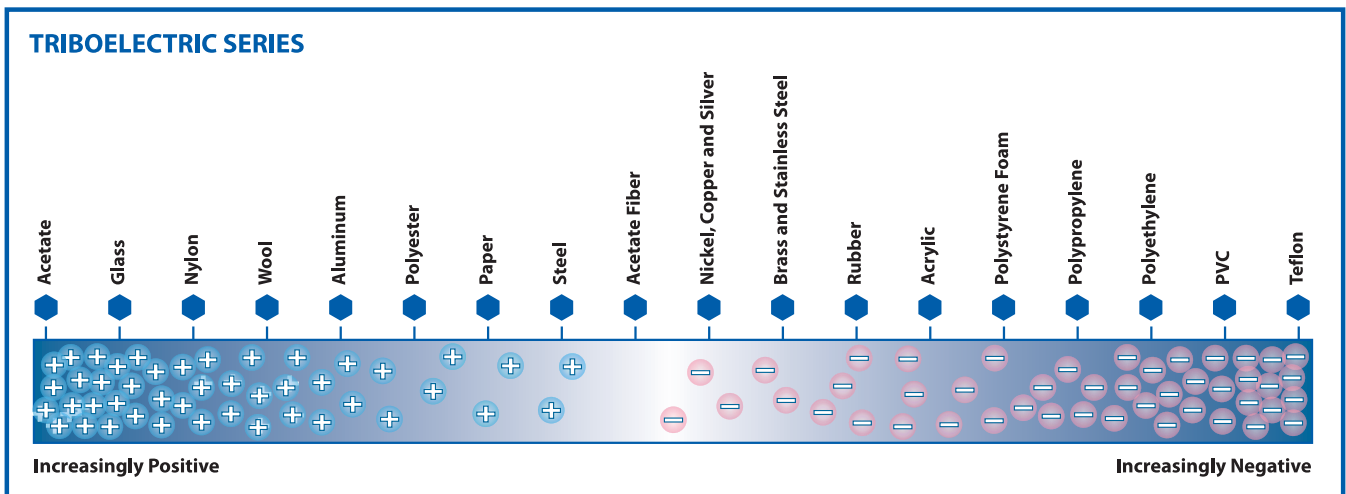

The Triboelectric Series chart shows the relative positive or negative charge of various materials.

FMX-004

Simco-Ion's **FMX-004** measures both positive and negative polarity charges up to ± 30 kV (30,000V) at a distance of 1". Results are simultaneously shown numerically and in bar graph format on the unique multi-colored display that also displays battery charge status. Power on/off, zero adjustment, Ion Balance (MODE) and hold are all push button operation. The hold button allows the display to retain the static charge reading. This is especially useful where display is difficult to see during measurement.

- Lightweight, compact design
- Range light assures accurate and repeatable measurements
- Automatic power off without activity



Optional Analog Output

Specifications

Power	9V, 6F22Y manganese battery
Display Features	Push button POWER, HOLD, ZERO and MODE (Ion Balance operation)
Read Out	Bar graph - Red LCD for positive polarity voltage; Blue LCD for negative polarity voltage; Battery capacity and error display indicators
Measurement Capability	AUTO: 0 - ± 1.49 kV (low range); ± 1.0 kV to ± 30.0 kV (hi range) HI Range: 0 - ± 30.0 kV LOW Range: 0 - ± 3.00 kV Ion Balance: 0 - ± 300 V
Measuring Distance	1" $\pm 1/64$ " (25 mm ± 0.5 mm); LEDs guide for correct distance (between charged object and fieldmeter)
Dimensions	4-7/8"L x 2-7/8"W x 1"D (123 x 73 x 25 mm)

TensION



Simco-Ion's **TensION** Voltage Detector enables you to check both AC & DC neutralizing and charging equipment. Without making contact with the actual equipment it gives you an easy and safe way to check if a high voltage is present. The tip of the TensION illuminates when a voltage is detected, providing an immediate indication the equipment is energized.

- No contact required
- Safe operation

Specifications

Power	2 size AAA replacable batteries 1.5V (included)
Temperature	-10°C to +50°C
Enclosure	Radilon-S HS(a), BE 170MO IP64
Dimensions	148L x 17 dia. mm (5.8" x 0.7")
Weight	40 grams

IQ Power Static Neutralizing System

Simco-Ion's **IQ Power Static Neutralizing System** is an unparalleled lineup engineered with the technology that brings complete monitoring intelligence within a user friendly interface. Designed for use in rugged industrial applications and leveraging many patented features, IQ Power provides superior ionization performance.

This fully integrated system is simple to install. With our "smart addressing" technology, devices can be added in a snap.

- Full PLC integration
- User controlled alarms
- Patented Auto-Tune technology
- Patented Dual Axis control
- Patented CLFB with charge sense technology
- Complete system monitoring for up to 10 neutralizing devices



IQ Power Control Station

The **IQ Power Control Station** is equipped with a full color touch panel interface. The Control Station combines data logging capabilities with user selectable time interval data points in addition to event logging capabilities.

It also provides four Output Modes of operation:

- **Fixed Mode** for system optimization based on average web conditions.
- **Manual Mode** for user adjusted output settings.
- **Auto-Tune Mode** for consistent live web reading and optimization based on current conditions.
- **Closed-loop Feedback (CLFB) Mode** allows the IQ Easy Sensor bar to directly control output.



IQ Easy Sensor Bar

Simco-Ion's **IQ Easy Sensor Bar** measures the field intensity of a charged web/target. Our unique design allows for various sensor configurations, positioning sensors across the web for a complete picture of your electrostatic charge issues.

When integrated with the Control Station, IQ Easy Sensor bars can be used with the Static Neutralizing bars using our propriety closed-loop feedback system minimizing the static charge level in real time.

- Full web width charge monitoring
- Over 40 bar lengths available
- Bars offer a variety of sensor locations
- Flexible mounting options



IQ Power & IQ Easy Static Neutralizing Bars

Unlike older technology bars, the **IQ Power** and **IQ Easy Static Neutralizing Bars** are highly efficient with 100% effective length. Our neutralizing bars are shockless, DC powered and built for long lasting durability and low maintenance.

Static neutralizing bars are offered in over 85 different lengths and three varieties to suit your application based on the web speeds or operating distance. All bars include rugged mounting hardware.

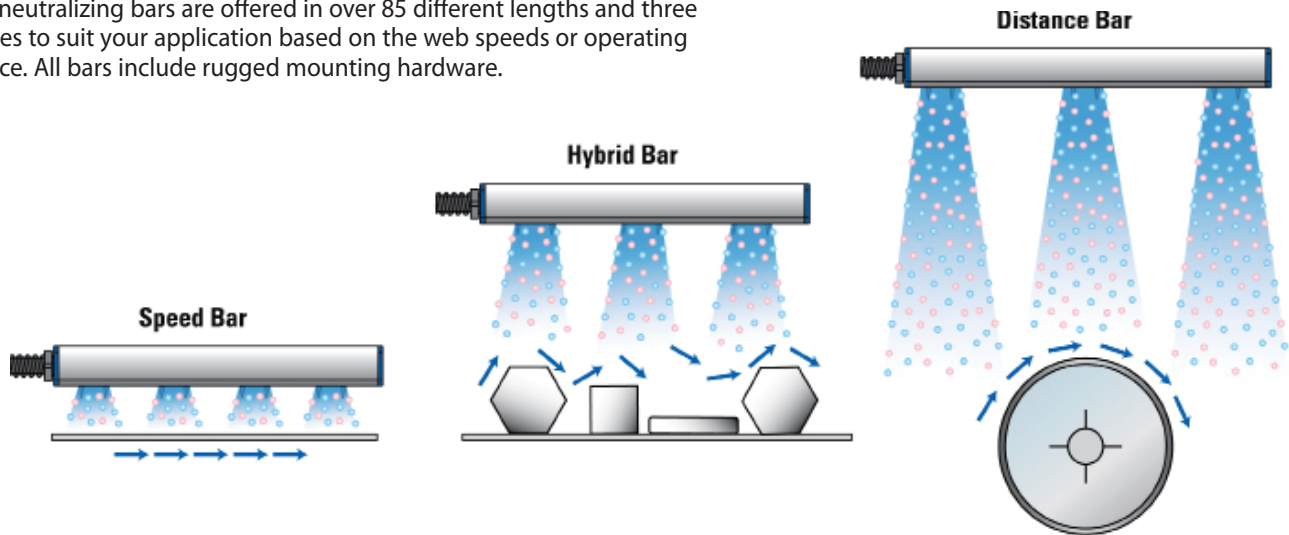

- Operating Voltage: 7 kV
- Duralloy™ or Tungsten Emitters
- Mounted 4" from material

- Operating Voltage: 9 kV
- Duralloy™ or Tungsten Emitters
- Mounted 18" from material

- Operating Voltage: 12 kV
- Duralloy™
- Mounted up to 30" from material



IQ Power Static Neutralizing Bar

The **IQ Power Static Bar** connects into the patented BPS Power Supply. Plug and play operation. Available in Speed, Hybrid, and Distance configurations.

IQ Power BPS

The **IQ Power BPS** power supply is designed for use with the IQ Power Static Neutralizing bars. It's industrial design provides patented one touch calibration, full ionization output readings including clean bar and fault indicators.

The patented connector system automatically senses bar type to adjust frequency and voltage.



Built In Power Supply



IQ Easy Static Neutralizing Bar

The **IQ Easy Static Bar** has an integrated high voltage power supply that requires only a low voltage input of 24 VDC, for a safer and cleaner install. IP-66 rated. Available in Speed and Hybrid configurations.

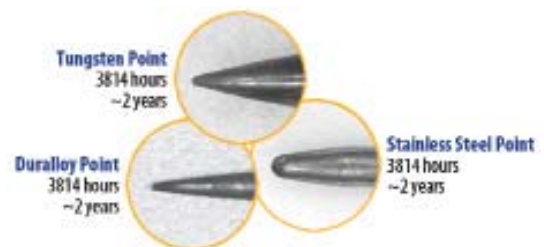

Our exclusive Duralloy™ emitter pin material is long lasting, requiring less voltage and generates greater quantities of ions, making this a reliable choice.

IQ Power HL Static Neutralizing System

The full **IQ Power HL Static Neutralizing System** is also available and approved for hazardous location installations, Class 1, Div 1, Group D. Leveraging all the benefits of the standard system, the IQ Power HL components are designed and approved for HL.

The heart of the IQ Power HL System is the power supply. It provides high voltage output power and processes all system intelligence to maintain and communicate complete static control.

There are two power supply choices available:

The **HL Power Supply** is approved for mounting outside the hazardous area.

The **HLC power supply** is approved for mounting inside classified hazardous locations. The HLC Power Supply requires a **Remote Display Monitor** which is used to display all critical indicators, such as service status and fault conditions.

The **IQ Power HL Static Neutralizing Bar** is available in Speed and Hybrid configurations.

Like the standard sensor bar, the **IQ Power HL Sensor Bar** operates in Closed Loop Feed Back mode. It connects to the system through the **IQ Power Sensor Interface**. The Sensor interface provides indicators and status for up to 8 connected sensors.

- Digital, not analog, technology offers higher accuracy and is impervious to noise.
- Sensor is intrinsically safe allowing for easier installation without requiring the use of conduit.
- Communications cannot be interrupted due to data verifying algorithm.



MEB Bar

Simco-Ion's **Shockless MEB** Static Bar is a very efficient and versatile static eliminator used in a wide variety of applications. Its' small size and ability to fit in tight spaces, makes it a favorite of machine builders. The MEB bar is also available with mounting studs and right angle cable exit for ease of installation.

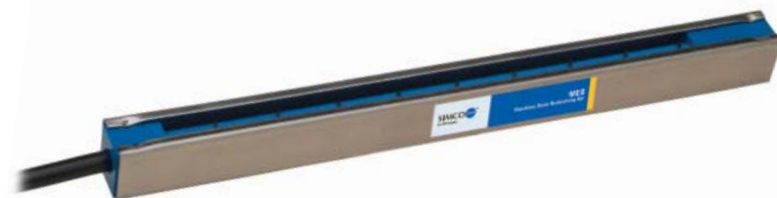

Specifications



Speed	1200 fpm (max)
Emitters	Stainless Steel
Power Supply	F Units, D Units
Mounting	1-3" from target surface
Enclosure	Stainless Steel and PVC
Dimensions	8.5-144" (215-3657 mm) overall length

IQ Power Nozzle

Simco-Ion's **IQ Power Nozzle** is a shockless pulse DC ionizer engineered to operate at 7 kV. The IQ Power Nozzle is compatible with Simco Ion's IQ Power Static Neutralizing system. Compatible with the IQ Power BPS Power Supply, IQ Power Nozzle users have worry free, one-touch setup and continuous active monitoring.

- Slotted and perforated configurations available
- Flexible installation allows multiple nozzles to be positioned on a single wire run
- Continuous monitoring of performance and status
- IP-66 rated against particulate and splash

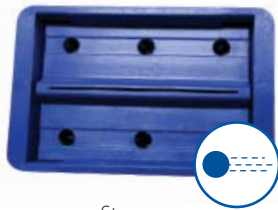

Stream
Slotted Configuration

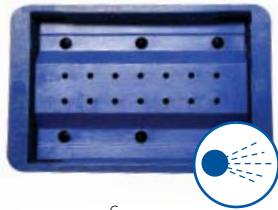

Spray
Perforated Configuration

The hardware provided allows for a variety of mounting options. The nozzle's position is securely held in place due to our locking detents. Straight and right angle quick disconnect air fittings provided.



IP66 Rated



High voltage cables are sold separately and are offered in 10, 20 and 30 foot lengths. The cables can be cut to the exact requirements of your application.

Specifications

Input Voltage	7 kVDC (IQ Power BPS speed mode) using specified HV cable
Air Input	80 psi (max)
Air Input Connections	Supplied 1/8 NPT straight of right angle for use with 1/4" O.D. tubing
Air Consumption	10 scfm @ 30 psi
Temperature	60°C (140°F) max
Dimensions	2.1"L x 2.1"W x 1.3"H (individual nozzle)
IP Rating	IP-66

HS Nozzle

Simco-Ion's **HS Nozzle** shockless pin-point ionizing air source is designed to mount individually, in series, or mounted on a standard air header.

Typical Use

Automotive/Converting/Plastics: Ideal for custom configuration around injection molded parts.



Spray

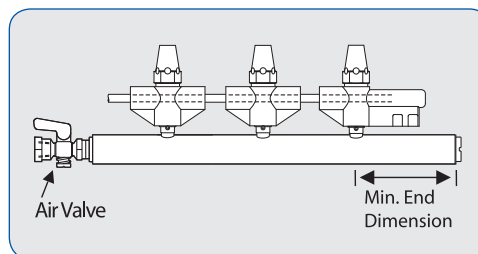

F Unit Power Supply

Specifications



Air Pressure	100 psi (max) clean dry air
Air Flow	4.4 scfm at 30 psi
Power Supply	F Units
Dimensions	2.5"H x 0.87"W x 3.5"L

HE Nozzle

Current limited, small profile **HE Nozzle** pin-point ionizing air source is designed to mount individually, in series, or mounted on a standard air header.

Typical Use

Packaging: Neutralize plastic seals for pharmaceutical bottles to ensure perfect placement.

Specifications

Air Pressure	100 psi (max) clean dry air
Air Flow	2.8 scfm at 30 psi
Power Supply	D Units
Dimensions	2" x 1" dia.



D Unit Power Supply



Stream



Ioncell™

Simco-Ion's **Ioncell** In-line Ionizer enables stunning performance in longer-length delivery lines by overcoming traditional ion recombination limitations; enabling focused ionized air to be delivered to previously inaccessible locations.

- Pipes ions through long tubes
- Compact design
- Various output attachments available
- Powered by low voltage power supply or through 24 VDC input
- Can daisy-chain up to 6 units

Specifications



Input Voltage	24 VDC
Output Current	5 μ A
Air Pressure	50 psi (max)
Emitters	Tungsten
Connectors	4 position modular; DC power IN
Operating Mode	Steady-state DC
Indicators	Green-Power On; Red-fault indicator (TTL level alarm output)
Temperature	32-122 °F (0-50 °C)
Enclosure	White, polycarbonate with 94V-0 flame rating
Dimensions	2.5"H x 1.3"W x 4.5"L (64 x 33 x 115 mm)
Weight	5.2 oz (145g)



Ring Output Applicator



Air Knife Output Applicator

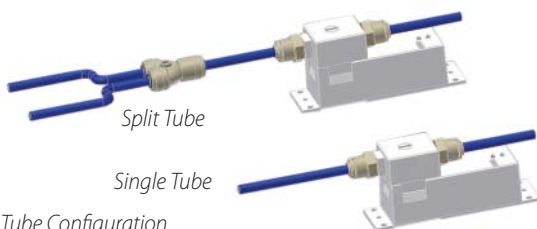

Split Tube

Single Tube

Output Tube Configuration

TopGun™

Simco-Ion's **Top Gun** features high blow-off force to provide efficient cleaning and rapid static discharge. All control functions are built into the gun for easy operator use: airflow control and a two-level LED to indicate both power on and ionization.

The Sidekick flexible neck frees the operator's hands during assembly and manufacturing processes. A foot pedal controls both ionization and airflow, and the flexible gun mount allows the operator to focus the ionization airflow where it is needed. It includes a steel bracket for easy benchtop mounting.

- Inherent balance to ±15V
- Static dissipative lightweight handle
- Operates on either compressed air or nitrogen
- Adjustable airflow control (5-100 psi)



Sidekick

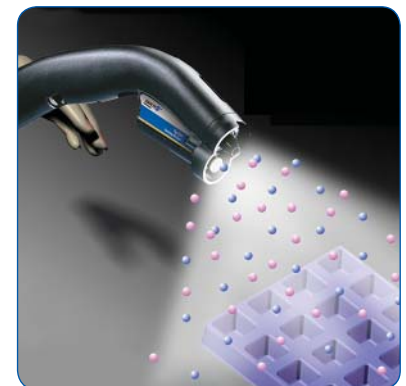

Neutralizing Thermoformed Trays

Specifications



Discharge Time	1.0 sec at 6", 30 psi; 0.5 sec at 2", 60 psi
Air Pressure	100 psi (max) clean dry compressed air
Air Flow	2.4 scfm at 30 psi; 4.6 scfm at 60 psi; 7.4 scfm at 100 psi
Cable	10' standard, 20' optional
Weight	1.8 lbs (gun and 10' hose assembly)

Cobra™

Simco-Ion's **Cobra** Static Neutralizing Blow-Off Gun provides a powerful blast of ionized air for cleaning and neutralizing large surfaces in rugged industrial environments. This lightweight, durable gun features an ergonomic handle to regulate blow-off force. An optional nozzle produces a fan-shaped air blast for covering large areas.



G Unit Power Supply

Specifications



Discharge Time	0.6 sec at 6" and 100 psi (decay 5000-500V, 20 pf plate)
Air Pressure	100 psi (max) clean dry compressed air
Air Flow	14 scfm at 50 psi, 22 scfm at 100 psi
Cable	20' standard, 40' optional
Power Supply	G Units
Weight	1.5 lbs (gun and 20' cable)

Curtain Transvector

Simco-Ion's **Transvector's** are highly efficient "air knives" or "curtains" of compressed air for superior blow off of dust and dirt. Simco-Ion's Transvector uses a patented technology which results in significantly less noise and less compressed air usage while outperforming other standard air knives. Simco-Ion's Transvector also has greater air amplification and a more uniform airflow.

Ionizing Curtain Transvector's provide an additional alternative to static bars when a powerful air curtain is desired for simultaneous cleaning and neutralizing of static charges. Operating on compressed air, the ionizing Curtain Transvector is designed to direct a stream or "curtain" of ionized air at a very specific area.

Simco-Ion Ionizing Curtain Transvector's are available with standard Simco-Ion static bars or Simco-Ion intrinsically safe static bars which are approved for Class 1 (Division 1, Group D) hazardous locations.

Typical Use

Finishing: Eliminating dust, dirt and static charges from autobody surfaces prior to entering paint booth.

Label Application: Eliminates dust, dirt and static charges for better label placement and adhesion.

Bottle Filling: Eliminates dust from exterior of bottles.

Injection Molding: Ionized air directed into mold cavity causes parts to release.

Static Bar Choices

- MEB
- IQ Power
- IQ Power HL
- IQ Easy

Specifications

Air Inlet	0.25" NPT
Air Pressure	10 psi (min) to 100 psi (max) clean dry air, oil free
Air Flow	4.3 scfm per inch at 80 psi
Power Supply	Based on static bar
Cable	10' standard length
Mounting	Transvector's may be mounted directly to air line or static bar mounting studs may be used on selected models
Dimensions	6", 12", 24" bar lengths in stock; 84" available



Magnum Force™

Simco-Ion's **Magnum Force** Air Knife Systems are custom-designed to provide superior heavy-duty surface cleaning or drying. When combined with Simco-Ion's static neutralizing bars, Magnum Force becomes a powerful tool for removing dust and dirt from flat or contoured surfaces. Where liquid removal is required, Magnum Force systems are ideal because of their powerful forced air thrust, low operating cost, and efficient operation.

- Clean, dry, uniform air provides superior cleaning capability
- Adjustable air thrust blades provide flexibility of performance
- Easy installation and positioning
- Corrosion resistant body and brackets

Specifications

Power Supply	Based on static bar
Enclosure	Anodized with powder coated ends
Dimensions	Up to 400" lengths in 6" increments (custom sizes available) x 4" and 6" dia.



Several sizes of direct or self-tensioning belt drive blowers available.

Typical Use

Finishing: Remove dust from automobile bodies, automotive components and large appliances prior to painting. Dry parts prior to painting.

Static Bar Options

- MEB bar standard
- Optional IQ Power HL bar for hazardous locations
- Optional IQ Power for high output ionization

Blower

- 208-230V, 460V or 575V, 50/60 Hz; 3-phase
- AMCA certified
- Silencer/Filter: 10 micron replaceable cartridge in coated steel casing



Magnum Force Air Nozzle

Magnum Force vs Compressed Air Knife Operation Cost*

Air Knife Length	Annual Cost (2000 hrs)		Blower Size	Savings with Magnum Force
	Compressed air knife (30 psi)	Magnum Force		
24"	\$1,633	\$323	3 HP	\$1,310
60"	\$4,082	\$538	5 HP	\$3,545
90"	\$6,124	\$806	7.5 HP	\$5,317
120"	\$8,165	\$806	7.5 HP	\$7,358
180"	\$12,247	\$1,613	15 HP	\$10,634

*Based on \$.07/Kw electric cost

Typical Magnum Force Installation

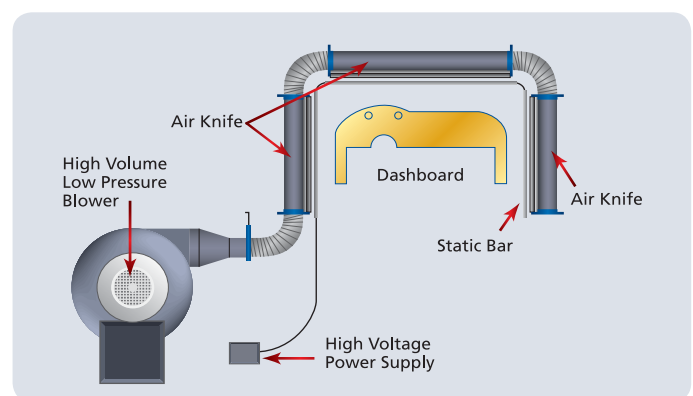

Magnum Force removes static and dust from plastic components such as dashboards, bumpers, and headlights.

Phoenix™

Simco-Ion's **Phoenix** Extended Range Ionizing Blower provides optimum static charge neutralization for a wide variety of industrial applications. Designed to efficiently cover a wide area with an inherently balanced ion stream, the Phoenix ionizer is powerful and portable.

- Extended range effective up to 10'
- Variable speed fan control
- Easily replaceable filters
- Point cleaner allows for easy maintenance
- Portable floor stand available
- High voltage indicator



Specifications



Input Voltage	120V, 60 Hz, 2.0A; 230V, 50/60 Hz, 1.25A (fan speed high)
Coverage	2' x 10' area
Air Flow	Variable, approximately 800-2000 fpm
Air Filter	Replaceable foam filter, 25 ppi
Audible Noise	68 dBA measured 2' in front of ionizer operating at high speed
Mounting	Optional floor stand 50-74" in 4" steps
Enclosure	Aluminum
Dimensions	16.38"W x 9.75"H x 13.25"D
Weight	16.1 lbs

Aerostat® PC

Simco-Ion's **Aerostat PC** Ionizing Air Blower provides localized coverage with superior charge decay efficiency. The Aerostat PC is designed to provide ionization to a targeted work area.

- Fast, targeted neutralization of static charges
- Lightweight, compact and quiet for unobtrusive use
- Built-in point cleaner simplifies maintenance
- Variable speed fan for airflow control
- Status lamp indicates high voltage is present at the emitter points
- Integrated heater for warm air flow if desired



Specifications



Input Voltage	120 VAC, 60 Hz; 0.1A (fan low heater off), 1.7A (fan high heater on)
Coverage	1' x 5' area
Air Flow	35-70 cfm
Enclosure	Aluminum and Polyester Power Coat
Dimensions	5-1/2"W x 8-5/8"H x 3-1/4"D
Weight	5.7 lbs (2.6 kg)

Sentry

Simco-Ion's **Sentry** Ionizing Air Blower provides static charge neutralization in industrial assembly and production environments. Its airflow is particularly well suited for neutralizing charges on three-dimensional objects and in areas 3' x 6' wide.

- Integrated power supply
- Point cleaner allows for easy maintenance
- Easily removable air filter for fast maintenance
- Bench stand or optional pedestal mount

Typical Use

Plastics: Parts handling, profile extruding



Specifications		CE	cUL _{us}
Input Voltage	120 VAC, 60 Hz, 0.9A (fan speed high)		
Discharge Time	1.0 sec at 1'; fan speed high (decay 1000-100V, 20 pf plate)		
Air Flow	70 cfm (low), 95 cfm (medium), 120 cfm (high)		
Coverage	3' x 6' area		
Dimensions	15.38"W x 4.5"H x 8.13"D		
Weight	17.8 lbs		

Aerostat® XP-20F

Simco-Ion's **Aerostat XP-20F HL** Ionizing Blower is approved for use in Class I, Division 1 and 2, Group D hazardous areas. This is the only blower available on the market with UL approval for use in hazardous areas. The XP-20F Static Control Blower can be powered by either the XP or by the XPM Power Supply. The XP Power Supply is approved for mounting within Class I, Division 1 and 2, Group D hazardous areas. The XPM power supply, which must be mounted outside the hazardous area, is approved for use in electrostatic finishing processes involving spray painting, dipping, coating, and liquid printing processes.

- Designed for use in rugged industrial environments as an intrinsically safe unit
- UL Listed for Class I, Division 1, Group D hazardous locations
- Supplied with air intake filter
- Connection to flexible or rigid metal conduit

Typical Use

Converting: Slitting and rewinding Packaging, Container cleaning.

Hazardous
Location
Approved



Specifications		cUL _{us}
Input Voltage	110-119 VAC, 57-63 Hz, 1.3A	
Discharge Time	0.9 sec at 1', fan speed high	
Air Flow	285 cfm	
Coverage	2' x 10' area	
Power Supply	XP Units, XPM Units	
Dimensions	18.63"W x 9"H x 16.75"D	



XP167/XP267



XPM167/XPM267

Compatible with
metalized films

Conveyostat™

Simco-Ion's **Conveyostat** Systems are designed to provide in-line ionization for neutralizing static charges on materials in pneumatic conveying systems to prevent them from becoming jammed.

The Conveyostat unit is typically mounted at the input to the cyclone or collection vessel so that trim materials are neutralized as they pass through the unit.

- Neutralizes conveying trim materials including metalized films
- Resistively coupled static bars enhance safety and prevent hard arcs
- Dual-phase ion generation ensures high neutralization rates
- Units available for indoor and outdoor installations
- Straight, flanged and rolled edges available
- Power supply includes short circuit detection
- Multiple diameters available

Specifications



Input Voltage	230 VAC, 60 Hz, 0.25A
Cables	Cable kits available 25'-100'
Power Supply	Simco-Ion's Dual Phase+ Power Supply
Enclosure	Stainless steel tube standard
Dimensions	24"L (36" with flanges) x 1.5"-24" dia. (larger sizes available)
Options	Flanges (compression coupling is standard) and outdoor weatherproof models available



Indoor unit with mounting flanges

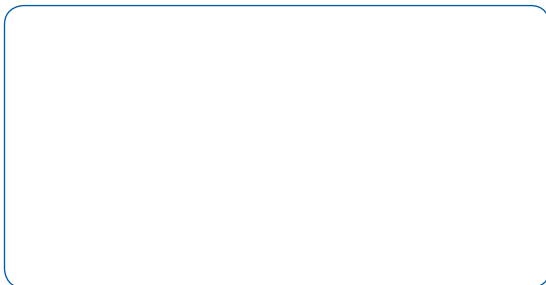

Indoor unit for small diameters



Indoor unit with quick disconnect edge

Slitter Trim Collection in Converting

Problem: Highly charged slitter trim materials cling to the sides of the cyclone of the trim collection system, forming a clog across the exit duct. The trim collection system must be shut down— affecting all operations producing slitter trim.

Solution: The Conveyostat system neutralizes trim materials prior to entering the cyclone. Once neutralized, the materials flow smoothly throughout the system, eliminating system shutdown.

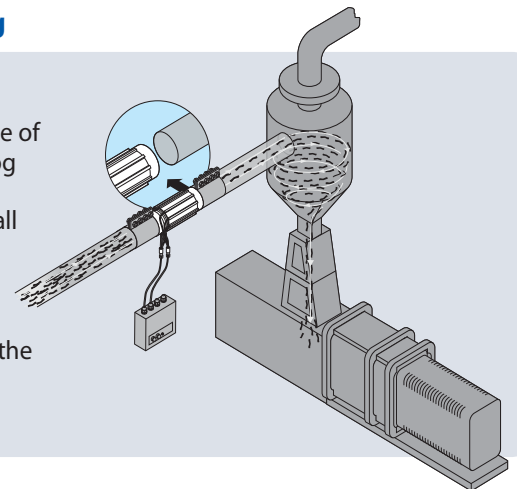

Dual Phase+ power supply produces high voltage for high speeds.

Chargemaster VCM™

Simco-Ion's **Chargemaster VCM** is programmable for either voltage or current control mode to supply the high voltage for charging bars and various charging applicators used to electrostatically bond materials. The Chargemaster VCM provides a simple and economical solution for a wide range of production processes maximizing the efficiency of the application.

The VCM is available in three versions; negative output voltage, positive output voltage and outputs of both positive and negative polarities (Bi-Polar).

- Run up to four charging bars or applicators
- Capable of voltage or current control mode operation
- Simplified programmable menu with status indicator
- Remote operation capability
- Short circuit protected output
- Powerful industry leading 5 mA pinning current



Bi-Polar (VCM-BP)



Wall mount

Specifications



Input Voltage	85-264 VAC @ 47-63 Hz (self adjusting)
Output Voltage	0-30 kV @ 5 mA; 0-60 kV @ 2.5 mA
Voltage Rise Time	Under 70 msec
Output Ports	4
Remote I/O	Analog Signals: 0-20/4-20 mA or 0-5/0-10 VDC via D/sub connector
Remote On/Off	via D/sub connector and programmable menu
Temperature	32-131°F (0-55°C)
Enclosure	Steel
Dimensions	30 kV: 10.5"W x 4.25"H x 13.5"D; 60 kV: 10.5"W x 4.25"H x 15"D
Weight	16.5 lbs

Chargemaster CM20™

Simco-Ion's **Chargemaster CM20** is a switch-mode power supply. The unit's output current is electronically restricted and protected against arcing. The output voltage can be set between 0 and the unit's maximum voltage (20 kV). The power supply incorporates functions for remote on/off and remote voltage adjustment.



Specifications



Output Voltage	0-20 kV; 0-0.7 mA (max)
Output Power	14W max
Output Ports	4
Voltage Control	Front-panel Digital
Dimensions	6" x 4.25" x 11.25"
Weight	7.5 lbs

MCM 30™

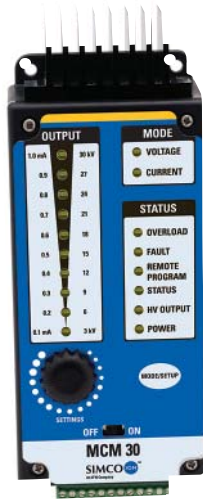

The **MCM 30** is a powerful switch-mode charging generator that supplies high voltage for charging bars and various charging applicators, which are used to temporarily bond materials. The MCM 30 packs a punch in a small size and provides simple and economical solutions for a wide range of production processes.

Specifications

Input Power	24 VDC, 3A, 75W (max)
Output Power	3-30 kVDC; 0.1-1 mA (single output)
Temperature	32-104°F (0-40°C)
Interface Connections	(12) position Terminal block and multi-purpose interface connector
Mounting	Integrated mounting brackets
Enclosure	ABS Plastic (UL94V-0), color: black
Dimensions	7.75"L x 3.00"W x 2.62"D (197L x 76W x 67D mm)
Weight	1.7 lb (0.77 kg)

Pinner™ & Pinner T™



Pinner & Pinner T Bars are energized by our charging generators to deliver a safe charge to temporarily pin or bond materials together. Quality construction and engineered for performance, the Pinner Series will help you achieve your Electrostatic Pinning goals whether working with IML or lamination. Pinner T is equipped with Tungsten emitter pins for longer life and lower resistance for greater pinning performance.

Specifications

Input Voltage	±30 kVDC (±50 kVDC with special mounting & insulation precautions)
Output Current	1.5 mA/ft max
Operating Environment	32-200°F (0-90°C); 70% RH (max), no dewing permissible
Operating Distance	1/2" to 3" (application & voltage dependent)
HV Cable	Flexible, abrasion-resistant, silicone outer jacket rated to ±50 kV
Enclosure	Glass filled vinyl ester (rugged, impact resistant, light grey color)
Weight	2.1 lb/foot

Pinner LP™



With its low profile design, the **Pinner LP Bar** is the smallest in Simco-Ion's Charging series making it easier to fit in tight spaces. A large variety of lengths are available allowing for the perfect fit. The Pinner-LP is engineered to provide stunning pinning performance for multiple applications, especially in roll-to-roll changeover.

Specifications

Input Voltage	±30 kVDC max
Output Current	Continuous Use: 0.75 mA/ft max Intermittent use: 1.50 mA/ft max
Operating Environment	32-200°F (0-90°C); 70% RH max, no dewing permissible
Operating Distance	1/2" to 3" (application & voltage dependent)
Dimensions	1"W x 1.9"H x (EL+2")L (EL = effective length 3-144" in 3" increment)
Weight	1.4 lb per foot

Pinner Easy™



Pinner Easy Bar

Remote Control Module

The innovative **Pinner Easy** Integrated Charging Bar incorporates both a static charging bar and charging generator into one. This design eliminates the need for high voltage wiring and makes the bar perfect for applications such as in-mold labeling, card insertion, roll-to-roll transfer and bag making. Both the charging generator and bar assembly are fully serviceable and replaceable, while the tungsten pins ensure longevity and reduce maintenance.

Specifications

Input Power	24 VDC, 2.5A max, supplied from Control Module via 10-conductor cable
Output Power	0-30 kVDC; 0-1 mA (1 mA max)
Operating Distance	1-4" (25-100 mm) typical
Dimensions	3.73"H x 2.73"W (95H x 69W mm) x 15-60" (381 x 1524 mm)
Weight	0.3 lb/in (5.4g/mm) of overall length

Pinner™ Charging Applicators

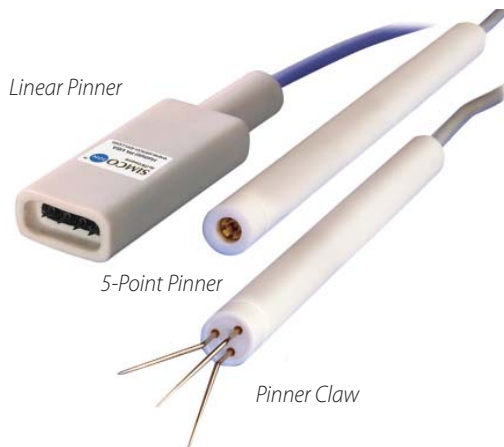

Linear Pinner

5-Point Pinner

Pinner Claw

The **Pinner Series** Static Charging Applicators consists of the Linear Pinner, 5-Point and Pinner Claw. Pinner applicators are arc resistant to avoid suspension of static charge and loss of pinning action.

- Current limited design for operator and equipment protection
- Available with replaceable pins to ensure maximum performance
- Minimized EMI and RFI generation, preventing disruption of controls

Specifications

Power Supply	30 kV/50 kV	
Points	Linear Pinner	4 removable
	5-point Pinner	5 fixed
	Pinner Claw	3 removable
Temperature	500°F (260°C)	
Dimensions	Linear Pinner	4.75" x 0.75" dia (120 x 19 mm)
	5-point Pinner	7" x 0.75" dia (178 x 19 mm)
	Pinner Claw	8.5" x 0.75" dia (216 x 19 mm)

Pinner Superbar™

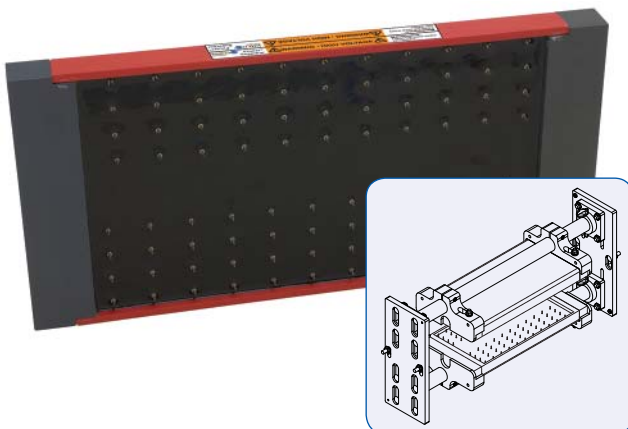

Stacker Bracket

The **Pinner Superbar** delivers more voltage and current than any high voltage applicator available. The Pinner Superbar is built for serious pinning tasks like catalog stacking.

Specifications

Type	Resistor-coupled, arc resistant	
Voltage	30 kV	
Emitter Points	316 stainless steel, removable, replaceable	
Inner Bar	RTV silicone compound	
Temperature	110°F (43°C)	
Cable	Removable, straight exit, 50 kV-rated, 221°F (105°C), 10' length (also available in 20' and 30' lengths)	
Mounting	Key slots (x4) 5/16-18 stainless steel nut and bolt kit	
Dimensions	6.5"W x 1.25D" PVC x 10.5", 14.25"	
Weight	5 lb 8 oz	

Teknek Cleaning Core

Teknek's matched elastomer rubber polymers are engineered adhesive rolls that offer the highest contact cleaning performance in the market.

Teknek offers a range of application specific elastomer rollers and matched pre-sheeted adhesive systems

Key Benefits

- ISO6123 manufactured compliance
- Elastomer rollers
 - Panel, Film, UTF, Ultraclean, Nanoclean
- Silicon free polymer rollers

WORLD LEADER
IN CONTACT CLEANING

teknek

An ITW Company

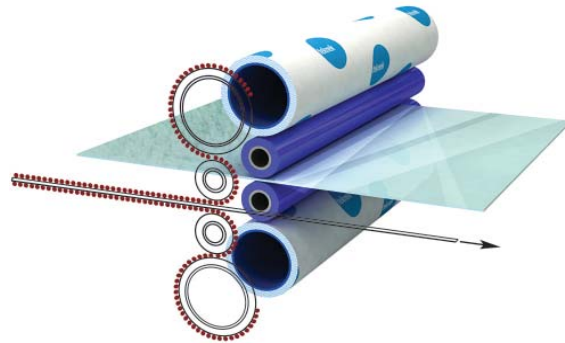

Cleaners for Narrow Webs

The narrow web cleaners have been designed to remove contamination from moving web of material.

Key Benefits

- Full side access of Teknek's pre-sheeted adhesive rolls for purging
- Flexible mounting—mounting in both vertical and horizontal positions based on application
- Low profile design
- Width range up to 30" web width



Cleaners for Wide Webs

Engineered for simple installation, continuous operation, ease of use and minimal maintenance. Proven contact cleaning for use with modern high value materials such as PET, polyimide, non-woven, copper, aluminum, BOPP and many others.

Key Benefits

- Low track, lightweight rollers
- Standard installation points with brackets on product
- Machined aluminum and stainless steel construction for a small footprint
- Width range from 30" up to 86" web width
- Custom widths available above 87"



Teknek Adhesives

Teknek adhesive rolls are pre-sheeted cleaning rolls matched to the application specific cleaning roller. Optimized to continuously clean the elastomer rollers in our clean machine guaranteed to not transfer anything back to your products surface.

Filmic Base – AREF

- Consists of an acrylic, pressure sensitive adhesive, coated on an oxydegradable base
- Teknek EcoFilm adhesive roll product is the silicone free adhesive roll system designed for use with the Teknek range of contact cleaning rollers

Paper Base – AREF

- Consists of an acrylic pressure sensitive adhesive, coated on a paper base
- The paper base has a silicone release coating which allows the product to be presented as a self-wound adhesive roll



Sheet Cleaners

The **CM8** sheet cleaner has been designed to integrate with most sheet cleaning applications. The system is fully programmable and offers forward and reverse operation. Many industries such as PCB, LCD, and graphics will benefit from this low profile, very flexible cleaner. It supports a range of thickness films and panels.

Key Benefits

- Sheet width up to 39"
- Sheet thickness (0.0015"-0.25") range
- Maximum line speeds of 130 ft per minute
- Double-sided cleaning



The **SMT** clean machine has been specifically designed to remove contamination from bare boards before solder paste, adhesive application and after laser marking. The design of the machine ensures full integration into all SMT lines, providing your process with the best contact cleaning system in the world.

The internal conveyor system supports the edges of the board throughout the cleaning process. The adjustable conveyor allows for any width of board to be processed.

Key Benefits

- SMEMA communication capable
- Stores pre-programmed board process settings
- On board static monitoring and alarming at pre-defined thresholds



Ion-O-VAC Mark I

Simco-Ion's **Mark I** uses a high pressure low volume vacuum collector to remove particulate down to 20 microns in size from webs and sheets. Typical models include brushes and static bars before and after the vacuum slot. An Ion-O-Vac is normally mounted where material has more than 30 degrees of surface contact with a roller or cylinder. This maximizes the cleaning effect of the high pressure vacuum.

- Single or double sided cleaning
- Contact and non-contact configurations
- Brackets and ducting included
- Manual or optional pneumatic retraction systems to raise and lower the heads

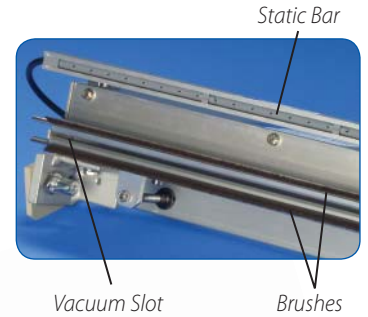

Typical High Pressure Hood Design/Installations

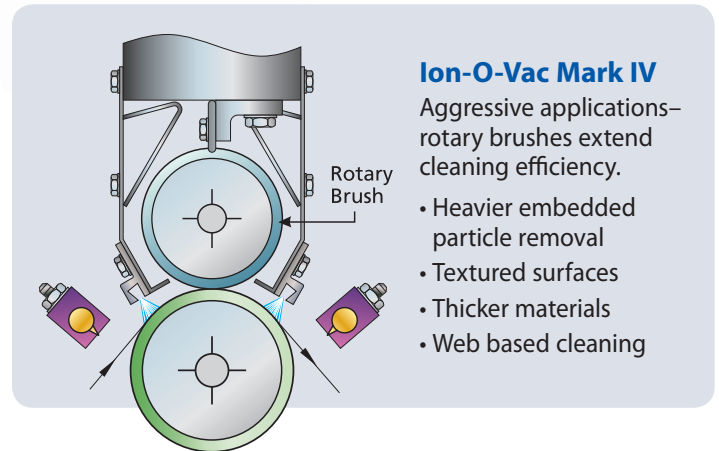
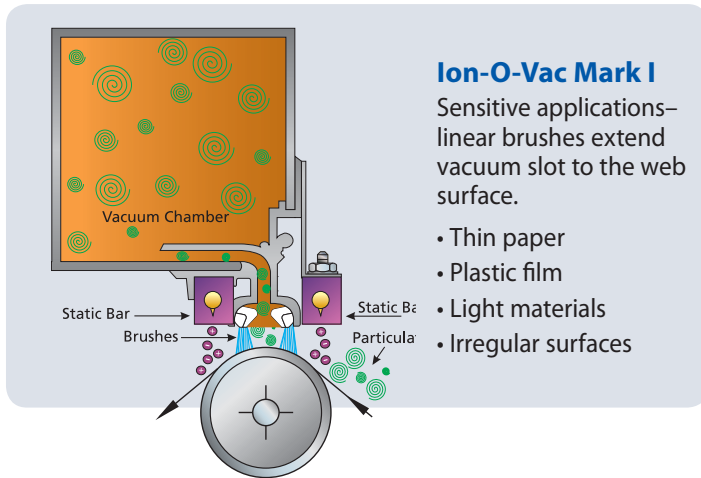

Ion-O-VAC Mark IV

Simco-Ion's **Mark IV** Systems utilize the power of rotary brush action to scrub the material surface, cleaning down to 15 microns. The scrubbing action of the Mark IV rotary brush system is designed for the toughest of materials that demand the cleanest surfaces.

- Double surface cleaning available for web presses
- Single or double sided cleaning arrangements
- Canister collector with cartridge filter
- Pre-filter and motor starter
- Ion-O-Vac head with rotary brush, drive and speed motor and controls, static eliminator and brackets
- Pneumatic lifts can be added for retraction during web threading



V-Force 30

Simco-Ion's **V-Force 30** narrow web vacuum system is a unique high performing industrial vacuum cleaning system for narrow web machines. The V-Force 30 combines the power of static neutralization with high vacuum, high volume and high velocity allowing for ultimate cleaning.

This powerhouse system includes a non-contact cleaning hood with active static neutralizing bars and a self-contained Air Control System with isolated particle collection in an all-in-one cabinet.

It can be easily installed onto any area of open web on most major narrow web presses and other narrow web machinery making it ideal for many applications.

Key Benefits

- Suitable for thin film applications
- Quiet operation (<70 dB)
- Simple installation w/ coaxial hose design
- Rugged stainless steel construction
- Low maintenance - easy replaceable filters
- Non-regenerative blower design

No
Compressed
Air Needed



Neutro-Vac®

Simco-Ion's **Neutro-Vac** Cleaner combines the power of a compressed air blast, static elimination, brushes and a high exhaust head to agitate the web, remove the static bond and evacuate surface particulate down to 20 microns in size. The Neutro-Vac systems are ideal for installation over unsupported webs from 3" to 300" wide.

- No adjustments required to accommodate a change in web width
- Single or double sided cleaning
- Contact, non-contact and hazardous location configurations
- HEPA after-filter available

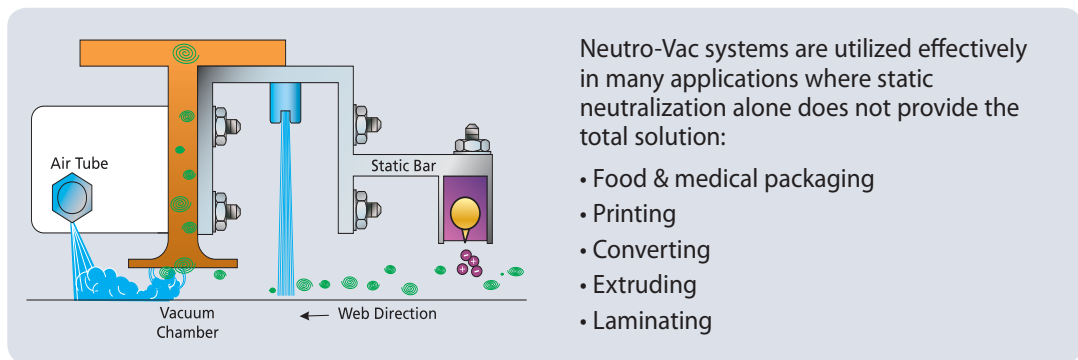

Neutro-Vac systems are utilized effectively in many applications where static neutralization alone does not provide the total solution:

- Food & medical packaging
- Printing
- Converting
- Extruding
- Laminating

Neutro-Vac Brush Contact Head with Static Bars & Air Tube (available without a brush as a non-contact version)



★ Headquarters

● Manufacturing & Sales Locations

Simco-Ion World Headquarters, U.S.A.

2257 North Penn Rd., Hatfield, PA 19440

Tel: (215) 822-6401

Fax: (215) 822-3795

www.simco-ion.com

customerservice@simco-ion.com

SIMCO IONTM
An ITW Company

Copyright © 2015 Simco-Ion

Printed in USA | Publication No. 5200522 Rev. L

Simco-Ion Europe

Postbus 71, Lochem, Holland NL-7240 AB

Tel: +31 (573) 288333

Fax: +31 (573) 257319

general@simco-ion.nl

www.simco-ion.nl

Simco-Ion Japan

1-2-4, Minatojima Nakamachi, Chuo-Ku
Kobe-City, Japan 650-0046

Tel: +81 (78) 303-4651

Fax: +81 (78) 303-4655

info@simcoion.jp

www.simcoion.jp

Simco-Ion China

2/F, Bldg 11, Heng Ming Zhu Tech Pk
Xiang Xing Road, Sha Jing, Bao An
Shenzhen, Guangdong 518104
China PRC

Tel: +886 (3) 461-7177

Fax: +886 (3) 463-5457

www.simco-ion.cn

Simco-Ion Australia

23 Ashford Avenue
Milperra, NSW, Australia 2214

Tel: +61 (2) 9772-3000

Fax: +61 (2) 9774-1223

ausesipd@simco-ion.com

Simco-Ion Latin America

Rua Peixoto Gomide 724
Sao Paulo, SP 01409-000 Brazil

Tel: +1 (215) 337-4595

Tel in Brazil: +55 (11) 3230-6854

Fax (Miami FL): +1 (305) 675-2353

lasalesipd@simco-ion.com



is a registered trademarks of Underwriters Laboratories, Inc.



is a registered trademarks of Underwriters Laboratories, Inc.



is a registered trademark of Canadian Standard Association.



is a registered trademark of Factory Mutual Research Corp.



is a registered trademark of Intertek Testing Services.



Products are determined compliant with applicable directives for Europe, through self declaration or third party examination.